

SUBMINIATURE DB Series

Features

- High-precision switch with high repeat accuracy
- Models available for operating temperatures up to 120°C
- Rated for currents up to 10 amp at 250VAC
- Range of auxiliary actuators available (can also be retrofitted); two mounting positions
- Variety of contact materials available to suit your application
- Mechanical life: up to 15 x 10⁶ operations
- Wide variety of terminal types available
- Numerous approvals

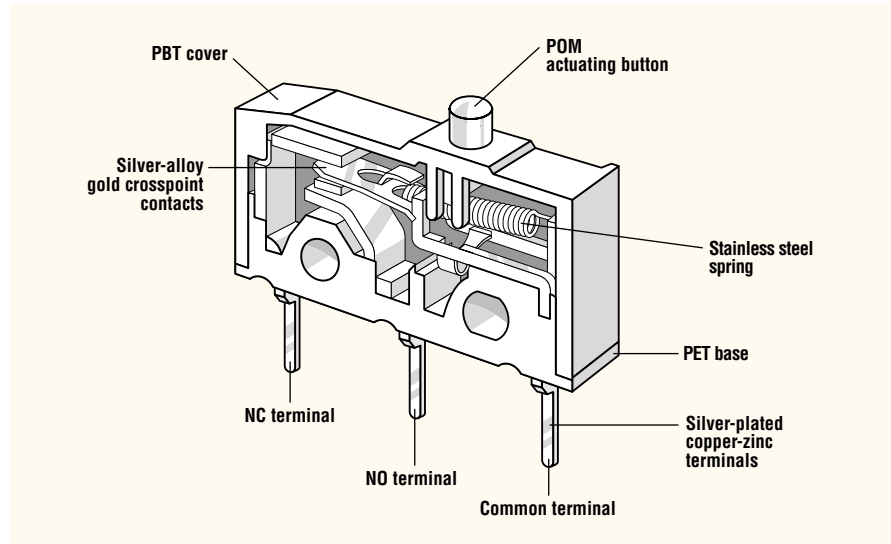

Electrical Ratings

Switch Series	EN61058 Rating	UL1054 Rating	Electrical Life at Rated Load	
			According to EN (Min. Operations)	According to UL (Min. Operations)
DB1	6A, 250V~	5A, 125/250VAC	10,000	6,000
DB2	10(1.5)A, 250V~	10.1A, 125/250VAC; 1/4HP, 125VAC	10,000	6,000
DB3	0.1A, 250V~	0.1A, 125/250VAC	50,000	6,000
DB5*	1A, 250V~	1A, 125/250VAC	50,000	6,000
DB6*	6A, 250V~	5A, 125/250VAC	50,000	6,000
DB7*	10(1.5A), 400V~	10.1A, 125/250VAC; 1/4HP, 125VAC	50,000	6,000

*85°C vs. T85.

Specifications

Electrical

Temperature Rating:	-40°C to +85°C / +120°C
Flammability Rating:	UL94V-O (PBT, PET) UL94HB (POM)

Materials

Base:	PET
Cover:	PBT
Actuator:	PBT, POM
Auxiliary Actuator:	Stainless Steel or Plastic
Terminals:	Silver-Plated Copper-Zinc
Contacts:	Silver Alloy Gold Crosspoint

PBT = Polybutyleneterephthalate • PET = Polyethyleneterephthalate • POM = Polyacetal



Dimensions inches (mm)

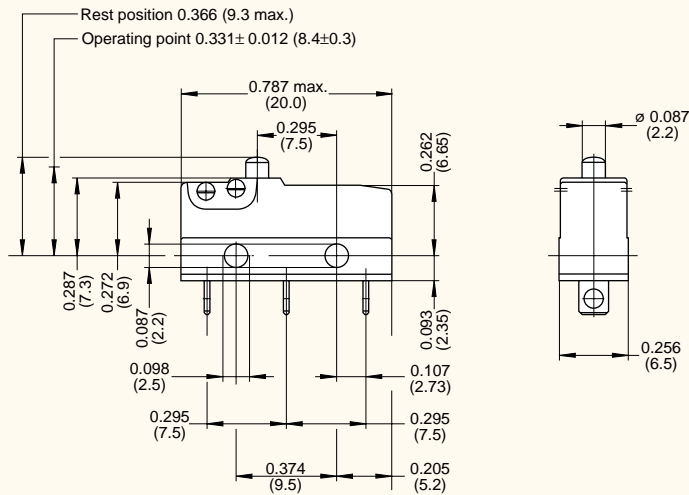

Terminal Options inches (mm)

QC Terminals
0.110 x 0.020 (2.8 x 0.5)

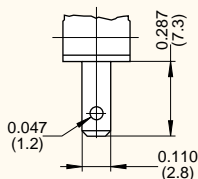

Solder Terminals – Short

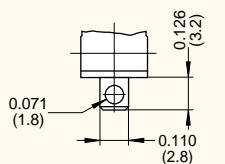

PCB Terminals – Straight
0.236 x 0.020 (1.3 x 0.5)

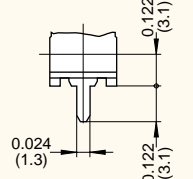

PCB Terminals – Straight
0.036 x 0.020 (0.6 x 0.5)

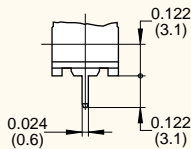

PCB Terminals RH Side w/o Location Pins
0.024 x 0.020 (0.6 x 0.5)

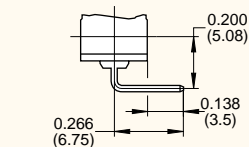

PCB Terminals LH Side w/o Location Pins
0.024 x 0.020 (0.6 x 0.5)

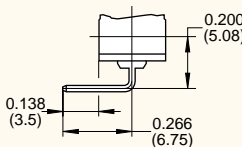

PCB Terminals RH Side with Location Pins
0.024 x 0.020 (0.6 x 0.5)

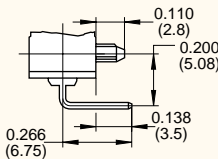

PCB Terminals LH Side with Location Pins
0.024 x 0.020 (0.6 x 0.5)

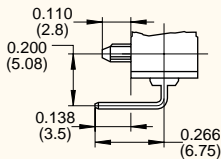

Top-down view of Lateral Terminals

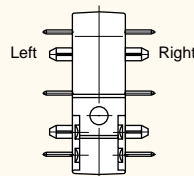

Drilling Patterns for PCB Terminals
0.051 x 0.020 (1.3 x 0.5)

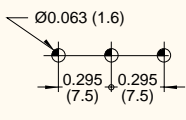

Drilling Patterns for PCB Terminals (Straight/Lateral w/o Location Pins)
0.024 x 0.020 (0.6 x 0.5)

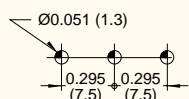

Drilling Patterns for PCB Terminals (Lateral with Location Pins)
0.024 x 0.020 (0.6 x 0.5)

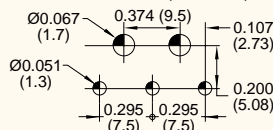

Auxiliary Actuator inches (mm)

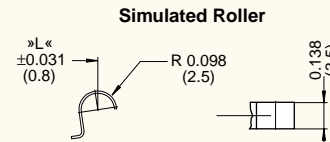
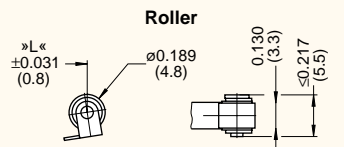
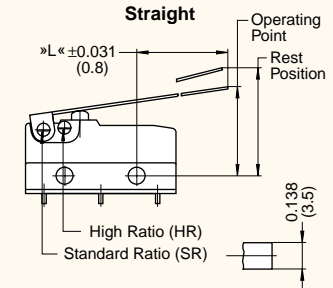

Straight – Plastic

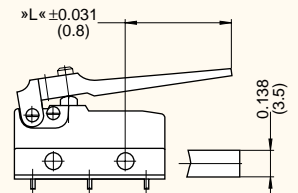

Roller – Plastic

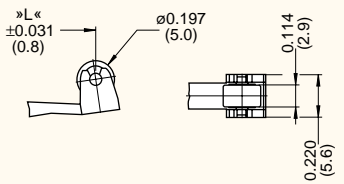

Simulated Roller – Plastic

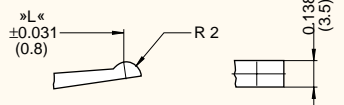

Contact Ratings at Direct Voltage

Switching Voltage	Switched Current Resistive Load		Inductive Load L/R=3ms	
	DB1	DB2	DB1	DB2
12V	6A	10A	6A	10A
24V	3A	5A	2A	4A
60V	1A	1A	0.5A	0.5A
110V	0.5A	0.5A	0.2A	0.2A
220V	0.25A	0.25A	0.1A	0.1A

Actuator Specifications — Standard Ratio

Actuator Code	Switch Type	Maximum Operating Force (gms.)	Maximum Pre-Travel inches (mm)	Operating Point inches (mm)	Minimum Over-Travel inches (mm)	Max. Movement Differential inches (mm)	Max. Rest Position inches (mm)	Actuation Length inches (mm)
AA	DB5	70	0.039 (1.0)	0.331±0.012 (8.4±0.3)	0.024 (0.6)	0.004 (0.10)	0.366 (9.3)	—
	DB1/3	150	0.039 (1.0)	0.331±0.012 (8.4±0.3)	0.024 (0.6)	0.004 (0.10)	0.366 (9.3)	—
	DB6	150	0.039 (1.0)	0.331±0.012 (8.4±0.3)	0.024 (0.6)	0.006 (0.15)	0.366 (9.3)	—
	DB2	250	0.039 (1.0)	0.331±0.012 (8.4±0.3)	0.024 (0.6)	0.004 (0.10)	0.366 (9.3)	—
	DB7	280	0.039 (1.0)	0.331±0.012 (8.4±0.3)	0.024 (0.6)	0.006 (0.15)	0.366 (9.3)	—
BA	DB5	70	0.039 (1.0)	0.331±0.012 (8.4±0.3)	0.024 (0.6)	0.004 (0.10)	0.366 (9.3)	—
	DB1/3	150	0.039 (1.0)	0.331±0.012 (8.4±0.3)	0.024 (0.6)	0.004 (0.10)	0.366 (9.3)	—
	DB6	250	0.039 (1.0)	0.331±0.012 (8.4±0.3)	0.024 (0.6)	0.006 (0.15)	0.366 (9.3)	—
	DB2	250	0.039 (1.0)	0.331±0.012 (8.4±0.3)	0.024 (0.6)	0.004 (0.10)	0.366 (9.3)	—
	DB7	280	0.039 (1.0)	0.331±0.012 (8.4±0.3)	0.024 (0.6)	0.006 (0.15)	0.366 (9.3)	—
<i>Auxiliary actuator, rear-mounted (RM)</i>								
LB	DB5	30	0.157 (4.0)	0.421±0.051 (10.7±1.3)	0.079 (2.0)	0.020 (0.5)	0.551 (14.0)	—
	DB1/3	60	0.157 (4.0)	0.421±0.051 (10.7±1.3)	0.079 (2.0)	0.020 (0.5)	0.551 (14.0)	—
	DB6	60	0.157 (4.0)	0.421±0.051 (10.7±1.3)	0.079 (2.0)	0.030 (0.75)	0.551 (14.0)	0.189 (4.8)
	DB2	100	0.177 (4.5)	0.421±0.063 (10.7±1.6)	0.059 (1.5)	0.028 (0.70)	0.551 (14.0)	—
	DB7	115	0.177 (4.5)	0.421±0.063 (10.7±1.6)	0.059 (1.5)	0.030 (0.75)	0.551 (14.0)	—
LC	DB5	25	0.177 (4.5)	0.437±0.059 (11.1±1.5)	0.079 (2.0)	0.024 (0.6)	0.591 (15.0)	—
	DB1/3	50	0.177 (4.5)	0.437±0.059 (11.1±1.5)	0.079 (2.0)	0.024 (0.6)	0.591 (15.0)	—
	DB6	50	0.177 (4.5)	0.437±0.059 (11.1±1.5)	0.079 (2.0)	0.047 (1.2)	0.591 (15.0)	0.276 (7.0)
	DB2	85	0.197 (5.0)	0.437±0.071 (11.1±1.8)	0.059 (1.5)	0.039 (1.0)	0.591 (15.0)	—
	DB7	100	0.197 (5.0)	0.437±0.071 (11.1±1.8)	0.059 (1.5)	0.047 (1.2)	0.591 (15.0)	—
LD	DB5	9	0.591 (15.0)	0.512±0.138 (13.0±3.5)	0.157 (4.0)	0.177 (4.5)	1.063 (27.0)	—
	DB1/3	18	0.591 (15.0)	0.512±0.138 (13.0±3.5)	0.157 (4.0)	0.177 (4.5)	1.063 (27.0)	1.654 (42.0)
	DB6	18	0.591 (15.0)	0.512±0.138 (13.0±3.5)	0.157 (4.0)	0.268 (6.8)	1.063 (27.0)	—
	DB2/7	—	—	—	—	—	—	on request
	DB5	30	0.157 (4.0)	0.630±0.051 (16.0±1.3)	0.079 (2.0)	0.020 (0.5)	0.748 (19.0)	—
SB	DB1/3	65	0.157 (4.0)	0.630±0.051 (16.0±1.3)	0.079 (2.0)	0.020 (0.5)	0.748 (19.0)	—
	DB6	65	0.157 (4.0)	0.630±0.051 (16.0±1.3)	0.079 (2.0)	0.043 (1.1)	0.748 (19.0)	0.098 (2.5)
	DB2	110	0.177 (4.5)	0.630±0.063 (16.0±1.6)	0.059 (1.5)	0.028 (0.7)	0.748 (19.0)	—
	DB7	125	0.177 (4.5)	0.630±0.063 (16.0±1.6)	0.059 (1.5)	0.043 (1.1)	0.748 (19.0)	—
	DB5	25	0.177 (4.5)	0.646±0.059 (16.4±1.5)	0.079 (2.0)	0.024 (0.6)	0.787 (20.0)	—
SC	DB1/3	55	0.177 (4.5)	0.646±0.059 (16.4±1.5)	0.079 (2.0)	0.024 (0.6)	0.787 (20.0)	—
	DB6	55	0.177 (4.5)	0.646±0.059 (16.4±1.5)	0.079 (2.0)	0.047 (1.2)	0.787 (20.0)	0.185 (4.7)
	DB2	95	0.197 (5.0)	0.646±0.071 (16.4±1.8)	0.059 (1.5)	0.039 (1.0)	0.787 (20.0)	—
	DB7	110	0.197 (5.0)	0.646±0.071 (16.4±1.8)	0.059 (1.5)	0.047 (1.2)	0.787 (20.0)	—
	DB5	9	0.591 (15.0)	0.720±0.138 (18.3±3.5)	0.157 (4.0)	0.177 (4.5)	1.260 (32.0)	—
SD	DB1/3	20	0.591 (15.0)	0.720±0.138 (18.3±3.5)	0.157 (4.0)	0.177 (4.5)	1.260 (32.0)	1.563 (39.7)
	DB6	20	0.591 (15.0)	0.720±0.138 (18.3±3.5)	0.157 (4.0)	0.268 (6.8)	1.260 (32.0)	—
	DB2/7	—	—	—	—	—	—	on request
	DB5	30	0.157 (4.0)	0.622±0.051 (15.8±1.3)	0.079 (2.0)	0.020 (0.5)	0.748 (19.0)	—
	DB1/3	65	0.157 (4.0)	0.622±0.051 (15.8±1.3)	0.079 (2.0)	0.020 (0.5)	0.748 (19.0)	—
RB	DB6	65	0.157 (4.0)	0.622±0.051 (15.8±1.3)	0.079 (2.0)	0.030 (0.75)	0.748 (19.0)	0.098 (2.5)
	DB2	110	0.177 (4.5)	0.622±0.063 (15.8±1.6)	0.059 (1.5)	0.028 (0.7)	0.748 (19.0)	—
	DB7	125	0.177 (4.5)	0.622±0.063 (15.8±1.6)	0.059 (1.5)	0.030 (0.75)	0.748 (19.0)	—
	DB5	25	0.177 (4.5)	0.638±0.059 (16.2±1.5)	0.079 (2.0)	0.024 (0.6)	0.787 (20.0)	—
	DB1/3	55	0.177 (4.5)	0.638±0.059 (16.2±1.5)	0.079 (2.0)	0.024 (0.6)	0.787 (20.0)	—
RC	DB6	55	0.177 (4.5)	0.638±0.059 (16.2±1.5)	0.079 (2.0)	0.047 (1.2)	0.787 (20.0)	0.185 (4.7)
	DB2	95	0.197 (5.0)	0.638±0.071 (16.2±1.8)	0.059 (1.5)	0.039 (1.0)	0.787 (20.0)	—
	DB7	110	0.197 (5.0)	0.638±0.071 (16.2±1.8)	0.059 (1.5)	0.047 (1.2)	0.787 (20.0)	—
	DB5	9	0.591 (15.0)	0.713±0.138 (18.1±3.5)	0.157 (4.0)	0.177 (4.5)	1.260 (32.0)	—
	DB1/3	20	0.591 (15.0)	0.713±0.138 (18.1±3.5)	0.157 (4.0)	0.177 (4.5)	1.260 (32.0)	1.563 (39.7)
RD	DB6	20	0.591 (15.0)	0.713±0.138 (18.1±3.5)	0.157 (4.0)	0.268 (6.8)	1.260 (32.0)	—
	DB2/7	—	—	—	—	—	—	on request
	DB5	24	0.177 (4.5)	0.437±0.059 (11.1±1.5)	0.079 (2.0)	0.024 (0.6)	0.591 (15.0)	—
	DB1/3	50	0.177 (4.5)	0.437±0.059 (11.1±1.5)	0.079 (2.0)	0.024 (0.6)	0.591 (15.0)	—
	DB6	50	0.177 (4.5)	0.437±0.059 (11.1±1.5)	0.079 (2.0)	0.035 (0.9)	0.591 (15.0)	0.276 (7.0)
WB*	DB2	85	0.177 (4.5)	0.437±0.059 (11.1±1.5)	0.079 (2.0)	0.024 (0.6)	0.591 (15.0)	—
	DB7	100	0.177 (4.5)	0.437±0.059 (11.1±1.5)	0.079 (2.0)	0.035 (0.9)	0.591 (15.0)	—
	DB5	18	0.236 (6.0)	0.480±0.071 (12.2±1.8)	0.118 (3.0)	0.031 (0.8)	0.669 (17.0)	—
	DB1/3	38	0.236 (6.0)	0.480±0.071 (12.2±1.8)	0.118 (3.0)	0.031 (0.8)	0.669 (17.0)	—
	DB6	38	0.236 (6.0)	0.480±0.071 (12.2±1.8)	0.118 (3.0)	0.047 (1.2)	0.669 (17.0)	0.551 (14.0)
WC*	DB2	63	0.236 (6.0)	0.480±0.071 (12.2±1.8)	0.118 (3.0)	0.031 (0.8)	0.669 (17.0)	—
	DB7	75	0.236 (6.0)	0.480±0.071 (12.2±1.8)	0.118 (3.0)	0.047 (1.2)	0.669 (17.0)	—
	DB5	25	0.177 (4.5)	0.469±0.055 (11.9±1.4)	0.079 (2.0)	0.024 (0.6)	0.591 (15.0)	—
	DB1/3	55	0.177 (4.5)	0.469±0.055 (11.9±1.4)	0.079 (2.0)	0.024 (0.6)	0.591 (15.0)	—
	DB6	55	0.177 (4.5)	0.469±0.055 (11.9±1.4)	0.079 (2.0)	0.035 (0.9)	0.591 (15.0)	0.220 (5.6)
VB*	DB2	90	0.177 (4.5)	0.469±0.055 (11.9±1.4)	0.079 (2.0)	0.024 (0.6)	0.591 (15.0)	—
	DB7	105	0.177 (4.5)	0.469±0.055 (11.9±1.4)	0.079 (2.0)	0.035 (0.9)	0.591 (15.0)	—
	DB5	25	0.177 (4.5)	0.630±0.055 (16.0±1.4)	0.059 (1.5)	0.024 (0.6)	0.748 (19.0)	—
	DB1/3	55	0.177 (4.5)	0.630±0.055 (16.0±1.4)	0.059 (1.5)	0.024 (0.6)	0.748 (19.0)	—
	DB6	55	0.177 (4.5)	0.630±0.055 (16.0±1.4)	0.059 (1.5)	0.035 (0.9)	0.748 (19.0)	0.205 (5.2)
ZB*	DB2	90	0.177 (4.5)	0.630±0.055 (16.0±1.4)	0.059 (1.5)	0.024 (0.6)	0.748 (19.0)	—
	DB7	105	0.177 (4.5)	0.630±0.055 (16.0±1.4)	0.059 (1.5)	0.035 (0.9)	0.748 (19.0)	—

*For 85°C only



Actuator Specifications — High Ratio

Actuator Code	Switch Type	Maximum Operating Force (gms.)	Maximum Pre-Travel inches (mm)	Operating Point inches (mm)	Minimum Over-Travel inches (mm)	Max. Movement Differential inches (mm)	Max. Rest Position inches (mm)	Actuation Length inches (mm)
<i>Auxiliary actuator, front-mounted (FM)</i>								
 MB	DB5	12	0.354 (9.0)	0.472±0.098 (12.0±2.5)	0.138 (3.5)	0.047 (1.2)	0.709 (18.0)	—
	DB1/3	25	0.354 (9.0)	0.472±0.098 (12.0±2.5)	0.138 (3.5)	0.047 (1.2)	0.709 (18.0)	—
	DB6	25	0.354 (9.0)	0.472±0.098 (12.0±2.5)	0.138 (3.5)	0.071 (1.8)	0.709 (18.0)	0.276 (7.0)
	DB2	40	0.354 (9.0)	0.472±0.118 (12.0±3.0)	0.138 (3.5)	0.059 (1.5)	0.709 (18.0)	—
	DB7	45	0.354 (9.0)	0.472±0.118 (12.0±3.0)	0.138 (3.5)	0.071 (1.8)	0.709 (18.0)	—
 MC	DB5	10	0.394 (10.0)	0.492±0.118 (12.5±3.0)	0.157 (4.0)	0.055 (1.4)	0.787 (20.0)	—
	DB1/3	22	0.394 (10.0)	0.492±0.118 (12.5±3.0)	0.157 (4.0)	0.055 (1.4)	0.787 (20.0)	—
	DB6	22	0.394 (10.0)	0.492±0.118 (12.5±3.0)	0.157 (4.0)	0.083 (2.1)	0.787 (20.0)	0.370 (9.4)
	DB2	35	0.394 (10.0)	0.492±0.138 (12.5±3.5)	0.157 (4.0)	0.071 (1.8)	0.787 (20.0)	—
	DB7	40	0.394 (10.0)	0.492±0.138 (12.5±3.5)	0.157 (4.0)	0.083 (2.1)	0.787 (20.0)	—
 MD	DB5	4	1.063 (27.0)	0.709±0.315 (18.0±8.0)	0.394 (10.0)	0.236 (6.0)	1.575 (40.0)	—
	DB1/3	9	1.063 (27.0)	0.709±0.315 (18.0±8.0)	0.394 (10.0)	0.236 (6.0)	1.575 (40.0)	1.713 (43.5)
	DB6	9	1.063 (27.0)	0.709±0.315 (18.0±8.0)	0.394 (10.0)	0.354 (9.0)	1.575 (40.0)	—
	DB2/7	—	—	—	—	—	—	on request
 UB	DB5	14	0.354 (9.0)	0.677±0.098 (17.2±2.5)	0.138 (3.5)	0.047 (1.2)	0.866 (22.0)	—
	DB1/3	30	0.354 (9.0)	0.677±0.098 (17.2±2.5)	0.138 (3.5)	0.047 (1.2)	0.866 (22.0)	—
	DB6	30	0.354 (9.0)	0.677±0.098 (17.2±2.5)	0.138 (3.5)	0.071 (1.8)	0.866 (22.0)	0.185 (4.7)
	DB2	50	0.354 (9.0)	0.677±0.118 (17.2±3.0)	0.138 (3.5)	0.059 (1.5)	0.866 (22.0)	—
	DB7	56	0.354 (9.0)	0.677±0.118 (17.2±3.0)	0.138 (3.5)	0.071 (1.8)	0.866 (22.0)	—
 UC	DB5	12	0.394 (10.0)	0.697±0.118 (17.7±3.0)	0.157 (4.0)	0.055 (1.4)	0.945 (24.0)	—
	DB1/3	25	0.394 (10.0)	0.697±0.118 (17.7±3.0)	0.157 (4.0)	0.055 (1.4)	0.945 (24.0)	—
	DB6	25	0.394 (10.0)	0.697±0.118 (17.7±3.0)	0.157 (4.0)	0.083 (2.1)	0.945 (24.0)	0.280 (7.1)
	DB2	40	0.394 (10.0)	0.697±0.138 (17.7±3.5)	0.157 (4.0)	0.071 (1.8)	0.945 (24.0)	—
	DB7	45	0.394 (10.0)	0.697±0.138 (17.7±3.5)	0.157 (4.0)	0.083 (2.1)	0.945 (24.0)	—
 UD	DB5	4	1.063 (27.0)	0.913±0.315 (23.2±8.0)	0.394 (10.0)	0.236 (6.0)	1.732 (44.0)	—
	DB1/3	9	1.063 (27.0)	0.913±0.315 (23.2±8.0)	0.394 (10.0)	0.236 (6.0)	1.732 (44.0)	1.622 (41.2)
	DB6	9	1.063 (27.0)	0.913±0.315 (23.2±8.0)	0.394 (10.0)	0.354 (9.0)	1.732 (44.0)	—
	DB2/7	—	—	—	—	—	—	on request
 TB	DB5	14	0.354 (9.0)	0.669±0.098 (17.0±2.5)	0.138 (3.5)	0.047 (1.2)	0.866 (22.0)	—
	DB1/3	30	0.354 (9.0)	0.669±0.098 (17.0±2.5)	0.138 (3.5)	0.047 (1.2)	0.866 (22.0)	—
	DB6	30	0.354 (9.0)	0.669±0.098 (17.0±2.5)	0.138 (3.5)	0.071 (1.8)	0.866 (22.0)	0.185 (4.7)
	DB2	50	0.354 (9.0)	0.669±0.118 (17.0±3.0)	0.138 (3.5)	0.059 (1.5)	0.866 (22.0)	—
	DB7	56	0.354 (9.0)	0.669±0.118 (17.0±3.0)	0.138 (3.5)	0.071 (1.8)	0.866 (22.0)	—
 TC	DB5	12	0.394 (10.0)	0.689±0.118 (17.5±3.0)	0.157 (4.0)	0.055 (1.4)	0.945 (24.0)	—
	DB1/3	25	0.394 (10.0)	0.689±0.118 (17.5±3.0)	0.157 (4.0)	0.055 (1.4)	0.945 (24.0)	—
	DB6	25	0.394 (10.0)	0.689±0.118 (17.5±3.0)	0.157 (4.0)	0.083 (2.1)	0.945 (24.0)	0.280 (7.1)
	DB2	40	0.394 (10.0)	0.689±0.138 (17.5±3.5)	0.157 (4.0)	0.071 (1.8)	0.945 (24.0)	—
	DB7	45	0.394 (10.0)	0.689±0.138 (17.5±3.5)	0.157 (4.0)	0.083 (2.1)	0.945 (24.0)	—
 TD	DB5	4	1.063 (27.0)	0.906±0.315 (23.0±8.0)	0.394 (10.0)	0.236 (6.0)	1.732 (44.0)	—
	DB1/3	9	1.063 (27.0)	0.906±0.315 (23.0±8.0)	0.394 (10.0)	0.236 (6.0)	1.732 (44.0)	1.622 (41.2)
	DB6	9	1.063 (27.0)	0.906±0.315 (23.0±8.0)	0.394 (10.0)	0.354 (9.0)	1.732 (44.0)	—
	DB2/7	—	—	—	—	—	—	on request
 GB*	DB5	10	0.394 (10.0)	0.508±0.102 (12.9±2.6)	0.118 (3.0)	0.055 (1.4)	0.787 (20.0)	—
	DB1/3	21	0.394 (10.0)	0.508±0.102 (12.9±2.6)	0.118 (3.0)	0.055 (1.4)	0.787 (20.0)	—
	DB6	21	0.394 (10.0)	0.508±0.102 (12.9±2.6)	0.118 (3.0)	0.083 (2.1)	0.787 (20.0)	0.370 (9.4)
	DB2	36	0.394 (10.0)	0.508±0.102 (12.9±2.6)	0.118 (3.0)	0.055 (1.4)	0.787 (20.0)	—
	DB7	42	0.394 (10.0)	0.508±0.102 (12.9±2.6)	0.118 (3.0)	0.083 (2.1)	0.787 (20.0)	—
 GC*	DB5	7	0.512 (13.0)	0.571±0.142 (14.5±3.6)	0.157 (4.0)	0.071 (1.8)	0.945 (24.0)	—
	DB1/3	16	0.512 (13.0)	0.571±0.142 (14.5±3.6)	0.157 (4.0)	0.071 (1.8)	0.945 (24.0)	—
	DB6	16	0.512 (13.0)	0.571±0.142 (14.5±3.6)	0.157 (4.0)	0.083 (2.4)	0.945 (24.0)	0.638 (16.2)
	DB2	26	0.512 (13.0)	0.571±0.142 (14.5±3.6)	0.157 (4.0)	0.071 (1.8)	0.945 (24.0)	—
	DB7	30	0.512 (13.0)	0.571±0.142 (14.5±3.6)	0.157 (4.0)	0.094 (2.4)	0.945 (24.0)	—
 HB*	DB5	11	0.354 (9.0)	0.531±0.098 (13.5±2.5)	0.098 (2.5)	0.055 (1.4)	0.787 (20.0)	—
	DB1/3	23	0.354 (9.0)	0.531±0.098 (13.5±2.5)	0.098 (2.5)	0.055 (1.4)	0.787 (20.0)	—
	DB6	23	0.354 (9.0)	0.531±0.098 (13.5±2.5)	0.098 (2.5)	0.083 (2.1)	0.787 (20.0)	0.311 (7.9)
	DB2	29	0.354 (9.0)	0.531±0.098 (13.5±2.5)	0.098 (2.5)	0.055 (1.4)	0.787 (20.0)	—
	DB7	45	0.354 (9.0)	0.531±0.098 (13.5±2.5)	0.098 (2.5)	0.083 (2.1)	0.787 (20.0)	—
 OB*	DB5	11	0.354 (9.0)	0.693±0.098 (17.6±2.5)	0.079 (2.0)	0.055 (1.4)	0.906 (23.0)	—
	DB1/3	23	0.354 (9.0)	0.693±0.098 (17.6±2.5)	0.079 (2.0)	0.055 (1.4)	0.906 (23.0)	—
	DB6	23	0.354 (9.0)	0.693±0.098 (17.6±2.5)	0.079 (2.0)	0.083 (2.1)	0.906 (23.0)	0.287 (7.3)
	DB2	39	0.354 (9.0)	0.693±0.098 (17.6±2.5)	0.079 (2.0)	0.055 (1.4)	0.906 (23.0)	—
	DB7	45	0.354 (9.0)	0.693±0.098 (17.6±2.5)	0.079 (2.0)	0.083 (2.1)	0.906 (23.0)	—

*For 85°C only

Ordering Information

DB 1			B —		B1		AA	
Series/Prefix			Code	Contact Configuration	Code	Terminal Type inches (mm)	Code	Actuator Type*
			+85°C Operating Temp					
Code	UL Rating 1054	EN 61058 Rating	E	SPST NO	B1	0.110 x 0.020 (2.8 x 0.5) QC, Straight	AA	Spherical-head w/o Auxiliary Actuator
1	5A, 125/250VAC	6A, 250V~	F	SPST NC	A1	Solder, Short	BA	Radius w/o Auxiliary Actuator
2	10.1A, 125/250VAC 1/4HP, 125VAC	10(1.5)A, 250V~	G	SPDT	C1	0.051 x 0.020 (1.3 x 0.5) PCB, Straight		
3	0.1A, 125/250VAC	0.1A, 250V	+120°C Operating Temp		D2	0.024 x 0.020 (0.6 x 0.5) PCB, RH Side with Location Pins		
5*	1A, 125/250VAC	1A, 250V	A	SPST NO	D3	0.024 x 0.020 (0.6 x 0.5) PCB, LH Side with Location Pins		
6*	5A, 125/250VAC	6A, 250V	B	SPST NC	D4	0.024 x 0.020 (0.6 x 0.5) PCB, RH Side		
7*	10.1A, 125/250VAC 1/4 HP, 125VAC	10 (1.5)A, 250V~	C	SPDT	D5	0.024 x 0.020 (0.6 x 0.5) PCB, LH Side		

*85°C only

Specifications subject to change without notice.

*For further actuators see Actuation Specifications table.